

15 AMP WATER PUMP CONTROLLER

SERVICE MANUAL

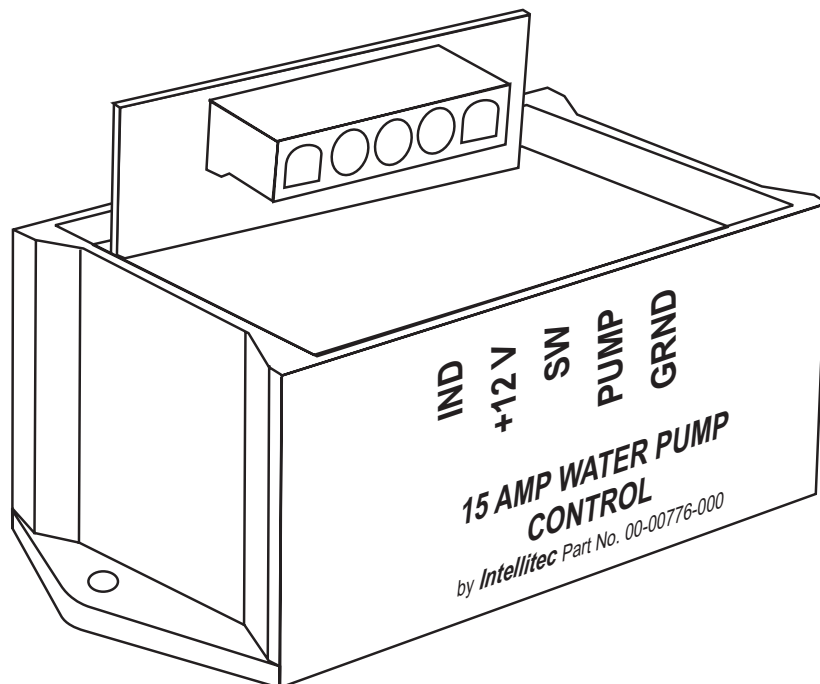

Part Number: 00-00776-000

Product Description

The 15 AMP WATER PUMP CONTROL provides a means to use low current remote switching for a 12 volt water pump. The control can be mounted close to the pump to reduce the amount of heavy wire needed to connect the pump. An unlimited number of low current remote switches can be wired with light gauge wire.

The control also provides an output to drive an on/off indicator. This output is capable of supplying up to 100 milliamps of current. It is short circuit protected.

Note: The 15 AMP WATER PUMP CONTROL controls the water pump which is connected to the 12 volt electrical system. Dangerous amounts of current are available at the terminals of the pump and the control. Inadvertent shorts at this box could result in damage and/or injury. **All servicing of this module should be done only by a qualified Service Technician.**

Tools required: Low current Test Light, Accurate Voltmeter (digital read-out preferred)

Intellitec

131 Eisenhower Lane North
Lombard, IL 60148
630.268.0010 / 1.800.251.2408

15 AMP WATER PUMP CONTROLLER

SERVICE MANUAL

How It Works

The 15 Amp Water Pump Control provides remote, low current, multi-point switching of a 12 volt water pump. To operate the pump, a low current, momentary switch is closed between the switch input of the control and ground. Each time the switch is pressed, the controller will be turned on and then off.

An output is provided on the controller to operate an indicator or indicators to show the state of the control. This output is capable of supplying up to 100 milliamps of current. This output is short circuit protected. If a short occurs at this output, it will turn off to protect itself. To reset this circuit, turn the control off and then on again.

Once the unit is turned on, it senses when the pump demands current and closes an internal relay to supply the pump current. The relay remains closed for as long as the pump is drawing current and an additional 12 seconds to prevent the relay from breaking pump current. After the 12 second delay period, the relay is turned off to reduce the battery drain.

To remotely turn the pump on and off, a momentary switch is connected between the switch input line and ground. Each time the switch is pressed, the system will turn on and then off.

15 AMP WATER PUMP CONTROLLER

SERVICE MANUAL

Trouble Shooting

Problem	Possible Cause/Solution
Pump not operating, but indicator is working.	Check for open fuse to water pump. If open, replace fuse. Check for 12 volts across the water pump. If no voltage, check for ground at water pump out on control. If not ground, replace control.
Control not turning on and off.	Check for ground on switch lead with voltmeter. If ground, locate short or stuck switch and repair.
Control turning on and off, pump working properly, indicator not operating.	Check for bad indicator. Check for ground on indicator lamp output.

15 AMP WATER PUMP CONTROLLER

SERVICE MANUAL

TYPICAL WIRING DIAGRAM

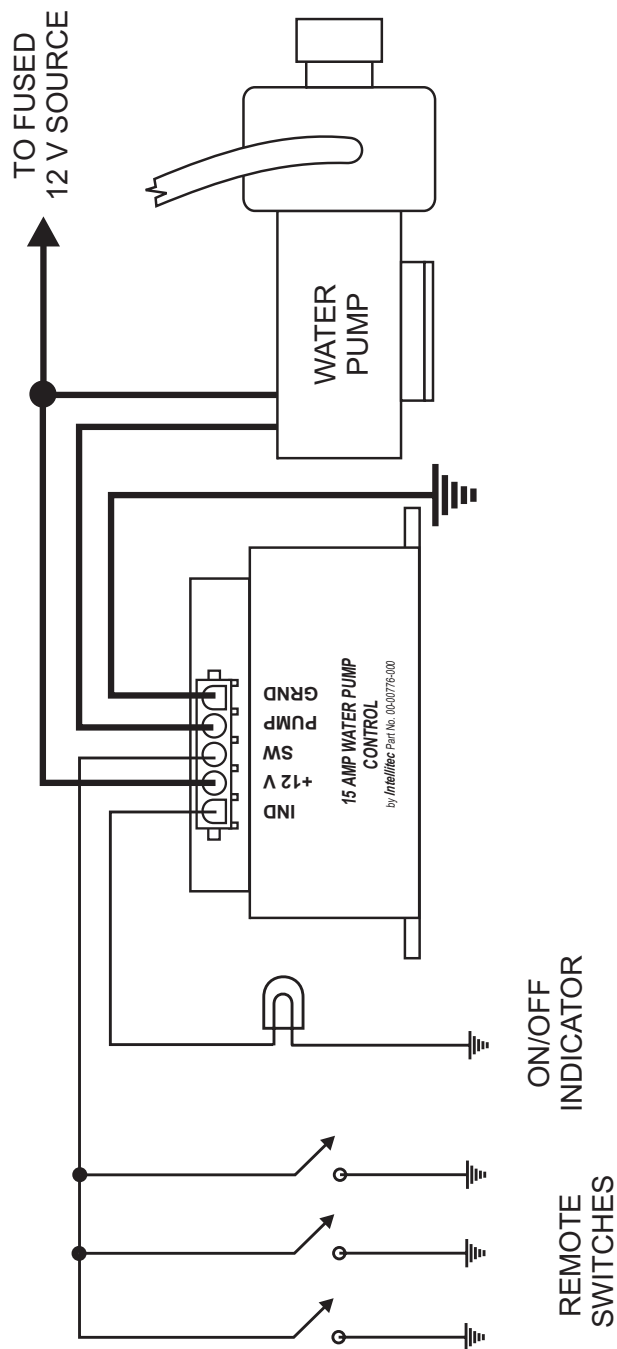

Intellitec

131 Eisenhower Lane North
Lombard, IL 60148
630.268.0010 / 1.800.251.2408